

Glass Channel-Metal Inserted

REPINCH-YM108X

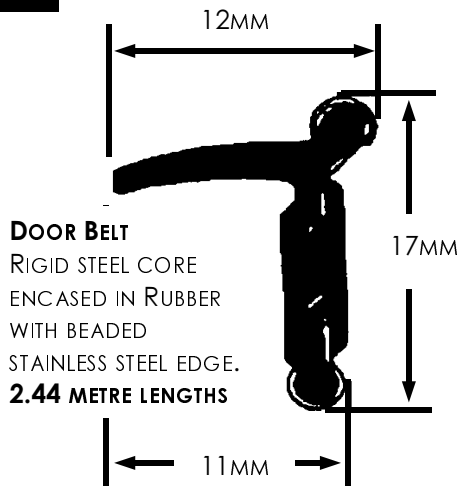

DOOR BELT
RIGID STEEL CORE
ENCASED IN RUBBER
WITH BEADED
STAINLESS STEEL EDGE.
2.44 METRE LENGTHS

REPINCH-YM13X

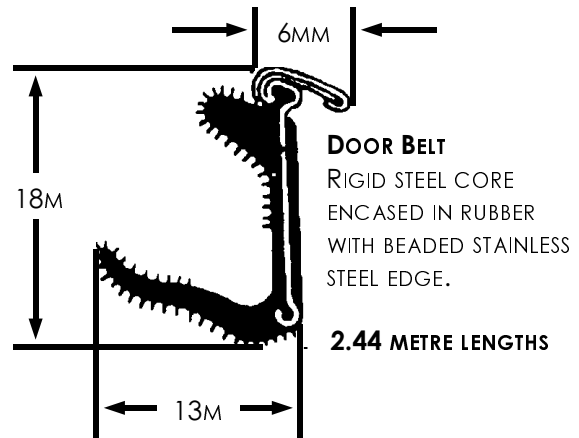

DOOR BELT
RIGID STEEL CORE
ENCASED IN RUBBER
WITH BEADED STAINLESS
STEEL EDGE.
2.44 METRE LENGTHS

REPINCH-YMR219

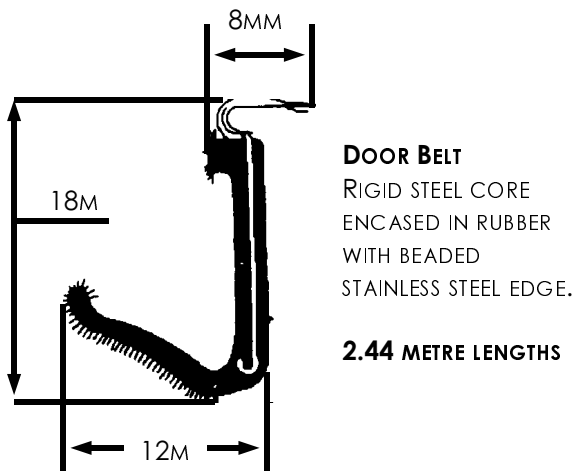

DOOR BELT
RIGID STEEL CORE
ENCASED IN RUBBER
WITH BEADED
STAINLESS STEEL EDGE.
2.44 METRE LENGTHS

REPINCH-YM54R

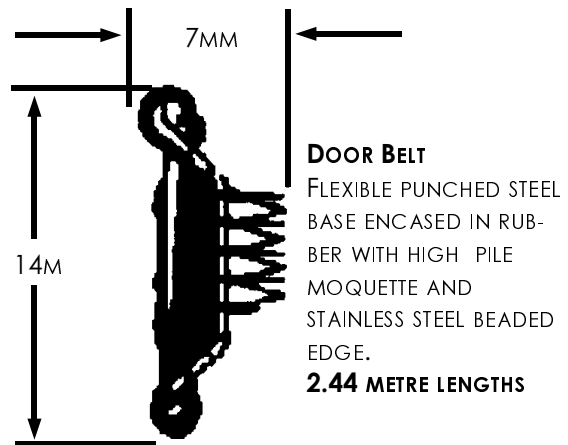

DOOR BELT
FLEXIBLE PUNCHED STEEL
BASE ENCASED IN RUB-
BER WITH HIGH PILE
MOQUETTE AND
STAINLESS STEEL BEADED
EDGE.
2.44 METRE LENGTHS

REPINCH-YM68

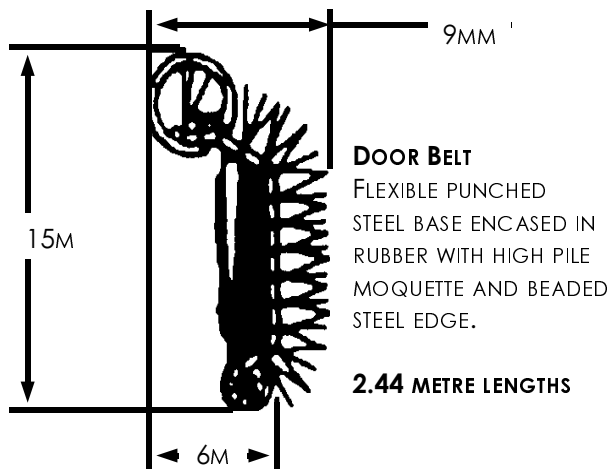

DOOR BELT
FLEXIBLE PUNCHED
STEEL BASE ENCASED IN
RUBBER WITH HIGH PILE
MOQUETTE AND BEADED
STEEL EDGE.
2.44 METRE LENGTHS

REPINCH-YM3

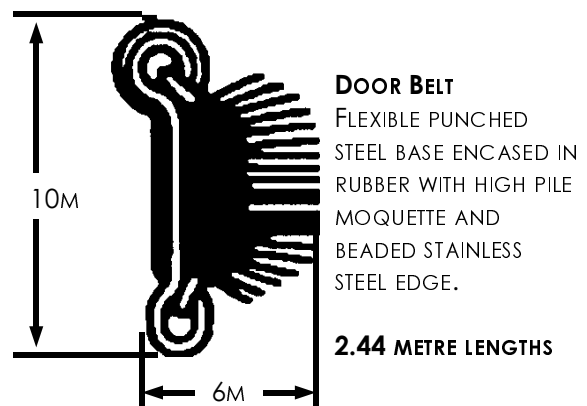

DOOR BELT
FLEXIBLE PUNCHED
STEEL BASE ENCASED IN
RUBBER WITH HIGH PILE
MOQUETTE AND
BEADED STAINLESS
STEEL EDGE.
2.44 METRE LENGTHS

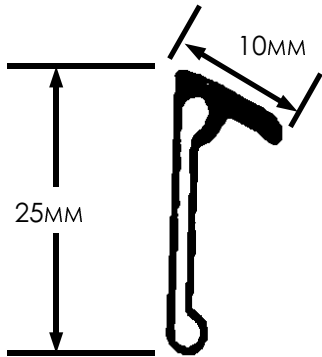

REPINCH -MA1

RIGID STEEL CORE ENCASED
IN RUBBER THROUGH A CROSS
HEAD EXTRUDER.

SUPPLIED IN 2.4 METRE
LENGTHS

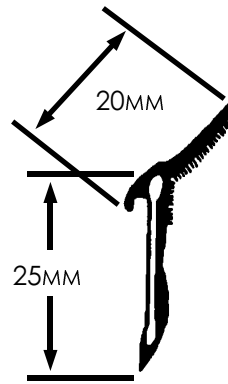

REPINCH -MA2

RIGID STEEL CORE ENCASED
IN RUBBER THROUGH A CROSS
HEAD EXTRUDER, FLOCKED
ON INNER SIDE OF LIP.

SUPPLIED IN 2.4 METRE
LENGTHS

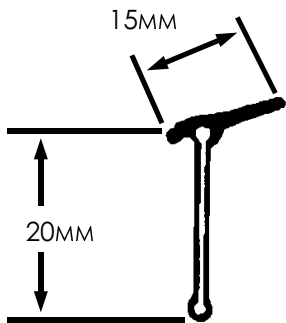

REPINCH -MA5

RIGID STEEL CORE ENCASED
IN RUBBER THROUGH A CROSS
HEAD EXTRUDER.

SUPPLIED IN 2.4 METRE

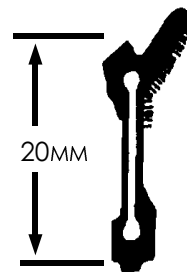

REPINCH -MA7

RIGID STEEL CORE ENCASED
IN RUBBER THROUGH A CROSS
HEAD EXTRUDER, FLOCKED
ON INNER SIDE OF LIP.

SUPPLIED IN 2.4 METRE
LENGTHS

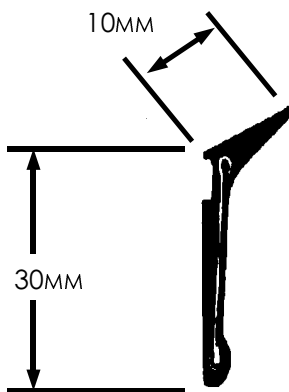

REPINCH -MA10

RIGID STEEL CORE ENCASED
IN RUBBER THROUGH A CROSS
HEAD EXTRUDER.

SUPPLIED IN 2 METRE LENGTHS

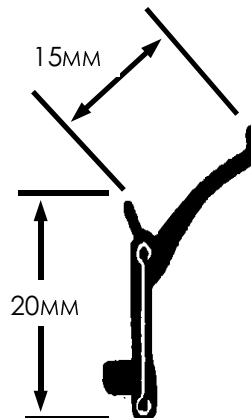

REPINCH -MA11

RIGID STEEL CORE ENCASED
IN RUBBER THROUGH A CROSS
HEAD EXTRUDER.

SUPPLIED IN 2 METRE LENGTHS

Glass Channel-Metal Inserted

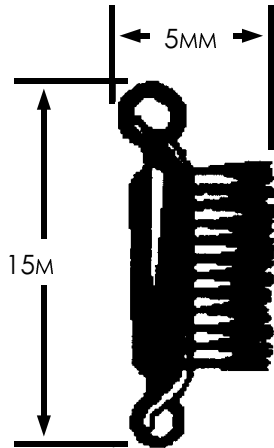

RE PINCH- C151CTN

FLEXIBLE, PUNCHED STEEL BASE, ENCASED IN RUBBER WITH HIGH PILE MOQUETTE AND STAINLESS STEEL BEADED EDGE. SUPPLIED IN 2.5 METRE LENGTHS

DOOR BELT

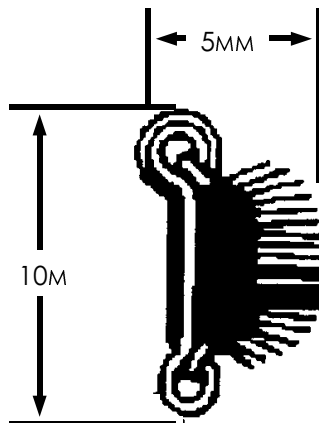

RE PINCH- C155CTW

FLEXIBLE, PUNCHED STEEL BASE, ENCASED IN RUBBER WITH HIGH PILE MOQUETTE AND STAINLESS STEEL BEADED EDGE.

SUPPLIED IN 2.5 METRE LENGTHS

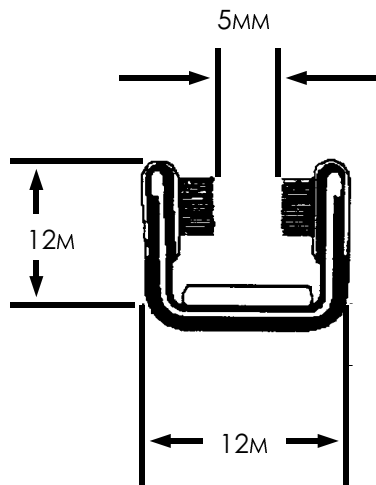

RE PINCH- C57FLT B

PUNCHED STEEL BASE, ENCASED IN RUBBER WITH HIGH PILE MOQUETTE AND FELT. SUPPLIED IN 2.5 METRE LENGTHS

FLEXIBLE CHANNEL

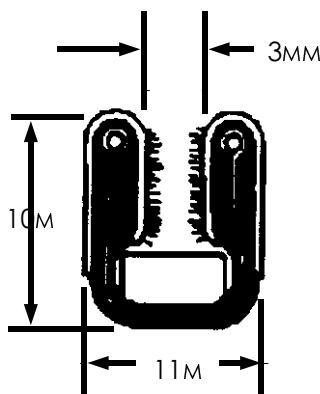

RE PINCH- C57FTS

PUNCHED STEEL BASE, ENCASED IN RUBBER WITH HIGH PILE MOQUETTE AND FELT .

SUPPLIED IN 2.5 METRE LENGTHS

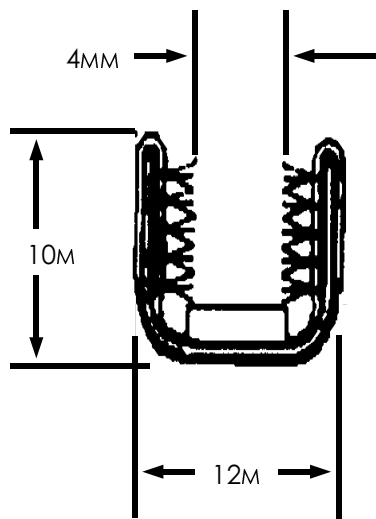

RE PINCH- C58FLT N

PUNCHED STEEL BASE, ENCASED IN RUBBER WITH HIGH PILE MOQUETTE AND FELT.

SUPPLIED IN 2.5 METRE LENGTHS

Glass Channel-Metal Inserted

A
37.

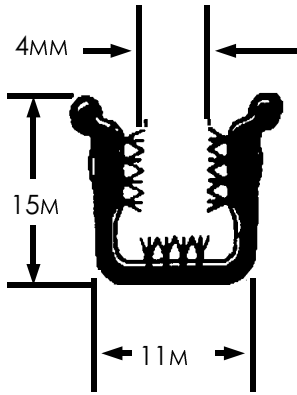

RE PINCH- Y630P

PUNCHED STEEL BASE,
ENCASED IN RUBBER WITH
HIGH PILE MOQUETTE AND
STAINLESS STEEL BEADED
EDGE.

**SUPPLIED IN 2.44 METRE
LENGTHS**

FLEXIBLE CHANNEL

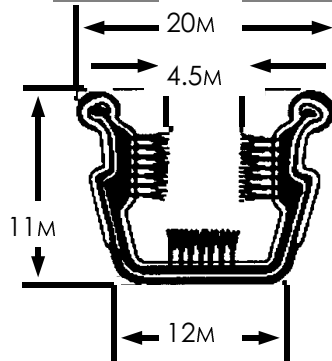

RE PINCH- Y620P

PUNCHED STEEL BASE,
ENCASED IN RUBBER WITH
HIGH PILE MOQUETTE, FELT
AND STAINLESS STEEL
BEADED EDGE.

**SUPPLIED IN 2.44 METRE
LENGTHS**

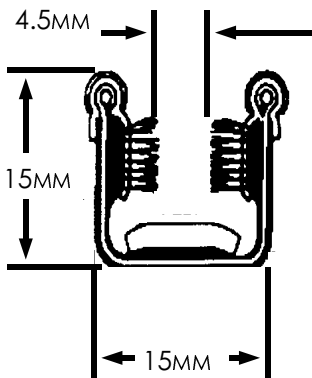

RE PINCH- Y526

PUNCHED STEEL BASE,
ENCASED IN RUBBER WITH
HIGH PILE MOQUETTE AND
STAINLESS STEEL BEADED
EDGE.

**SUPPLIED IN 2.44 METRE
LENGTHS**

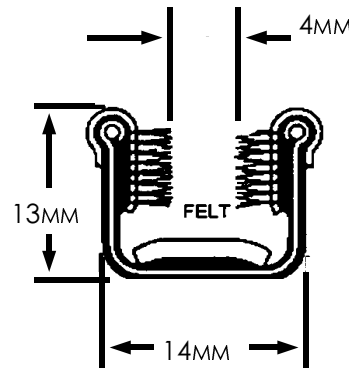

RE PINCH- C52FLT

PUNCHED STEEL BASE,
ENCASED IN RUBBER WITH
HIGH PILE MOQUETTE AND
FELT LINING.

SUPPLIED IN 30 METRE COIL

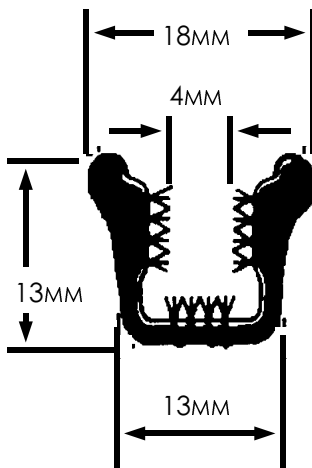

RE PINCH- C53FLTM

PUNCHED STEEL BASE,
ENCASED IN RUBBER WITH
HIGH PILE MOQUETTE AND
FELT LINING.

SUPPLIED IN 30 METRE COIL

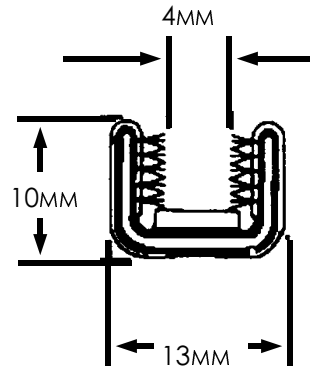

RE PINCH- C56FLTVW

PUNCHED STEEL BASE,
ENCASED IN RUBBER WITH
HIGH PILE MOQUETTE AND
FELT LINING.

SUPPLIED IN 30 METRE COIL

Glass Channel-Metal Inserted

RIGID CHANNEL

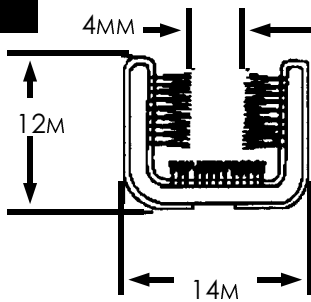

RE PINCH- C103RLT

ROLLED, FORMED RIGID STEEL BASE, RUBBER ENCASED WITH FELT AND MOQUETTE LINING.

SUPPLIED IN 2.5 METRE LENGTHS

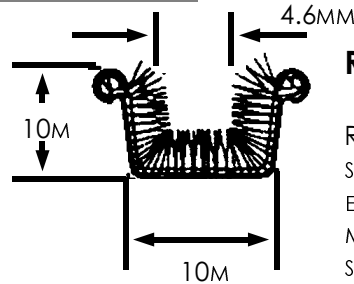

RE PINCH- C313

ROLLED, FORMED RIGID STEEL BASE, RUBBER ENCASED WITH FELT AND MOQUETTE LINING AND STAINLESS STEEL EDGES.

SUPPLIED IN 2.44 METRE LENGTHS

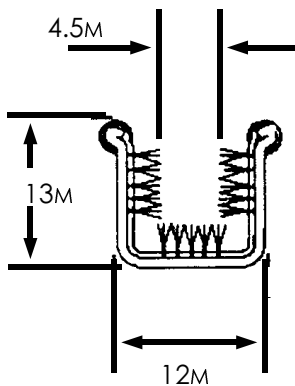

RE PINCH- Y658X

ROLLED, FORMED RIGID STEEL BASE, RUBBER ENCASED WITH FELT AND MOQUETTE LINING AND STAINLESS STEEL EDGES.

SUPPLIED IN 2.44 METRE LENGTHS

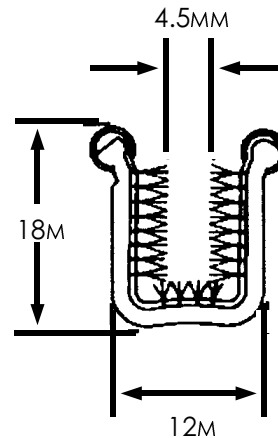

RE PINCH- Y619P

ROLLED, FORMED RIGID STEEL BASE, RUBBER ENCASED WITH FELT AND MOQUETTE LINING AND STAINLESS STEEL EDGES.

SUPPLIED IN 2.44 METRE LENGTHS

Glass Channel-Flocked Rubber



RE FLOCKING-11-022



RE FLOCKING-14-013



RE FLOCKING-14-016



RE FLOCKING-31-025



RE FLOCKING-32-006



RE FLOCKING-39-037



RE FLOCKING-39-068



RE FLOCKING-39-069

Glass Channel-Flocked Rubber



RE FLOCKING-39-401



RE FLOCKING-39-424



RE FLOCKING-39-425



RE FLOCKING-39-426



RE FLOCKING-39-427



RE FLOCKING-39-430



RE FLOCKING-39-500



RE FLOCKING-39-501

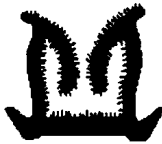

RE FLOCKING-39-502



RE FLOCKING-39-622
(288209)



RE FLOCKING-39-628
(293089)



RE FLOCKING-51-903



RE FLOCKING-64-009



RE FLOCKING-64-017



RE FLOCKING-64-020



RE FLOCKING-64-026



RE FLOCKING-64-028



RE FLOCKING-64-065



RE FLOCKING-64-067



RE FLOCKING-64-139



RE FLOCKING-64-143



RE FLOCKING-64-193



RE FLOCKING-MDB001



RE FLOCKING-SS1150

Pinchwelds - EPDM Rubber and Sponge

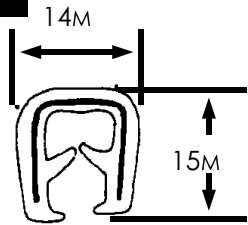

REPINCH-002

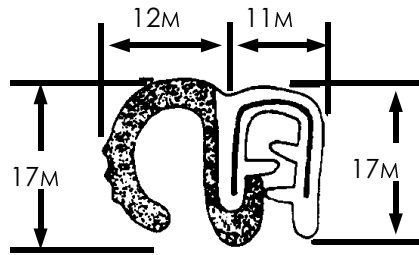

REPINCH-003

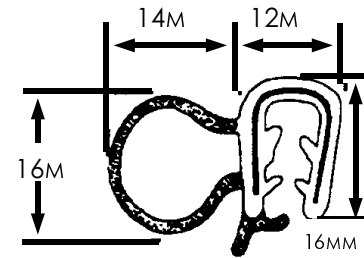

REPINCH-004

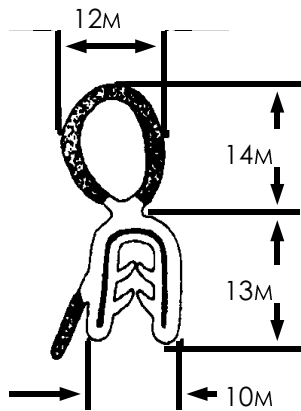

REPINCH-005

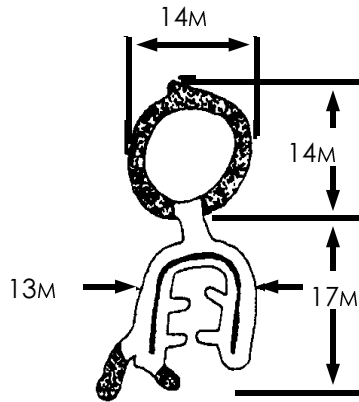

REPINCH-006

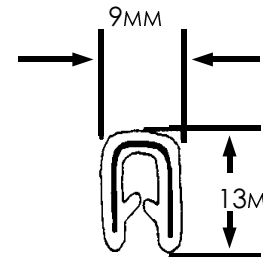

REPINCH-007

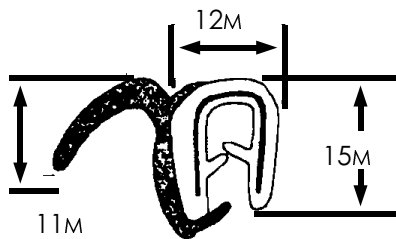

REPINCH-008

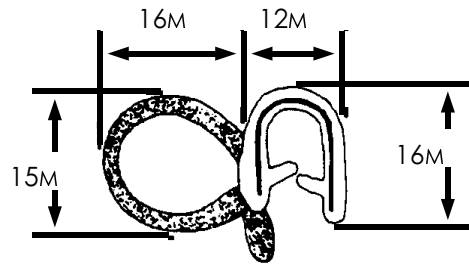

REPINCH-009

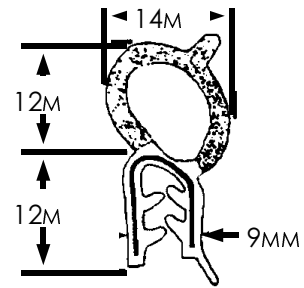

REPINCH-010

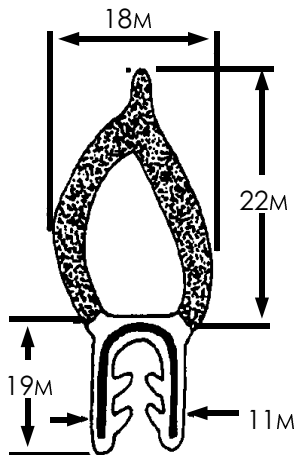

REPINCH-011

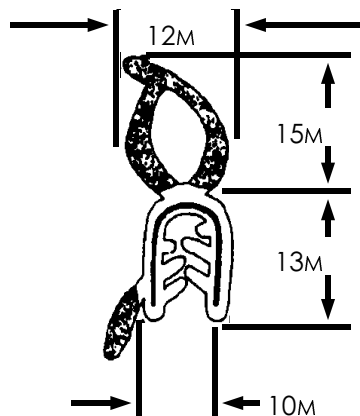

REPINCH-012

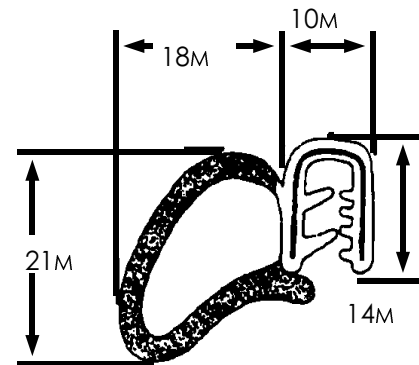

REPINCH-013

Pinchwelds - EPDM Rubber and Sponge

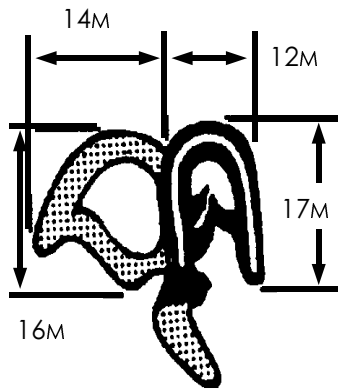

REPINCH-014

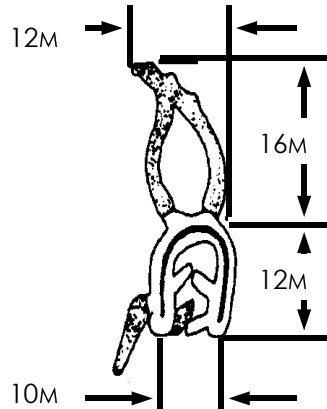

REPINCH-015

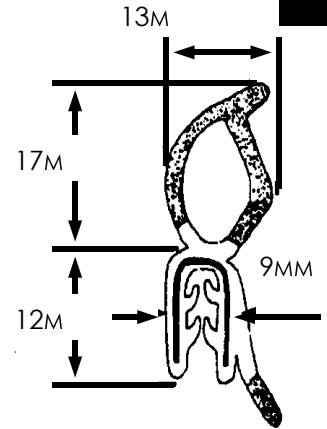

REPINCH-016
EQUIV. TO BS263376

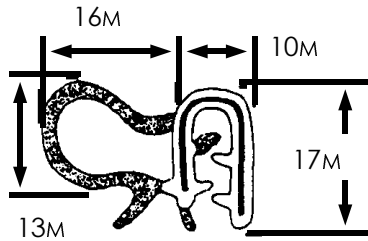

REPINCH-017

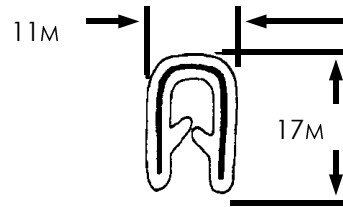

REPINCH-018

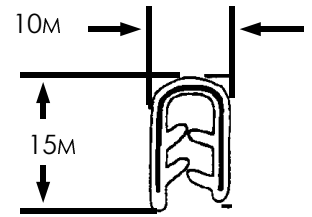

REPINCH-020

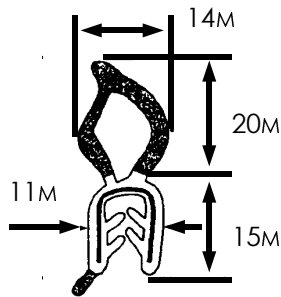

REPINCH-022

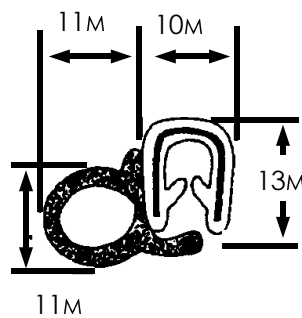

REPINCH-040

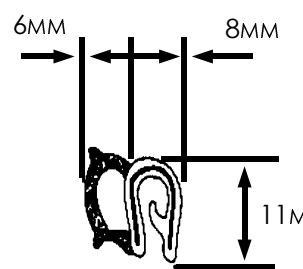

REPINCH-056

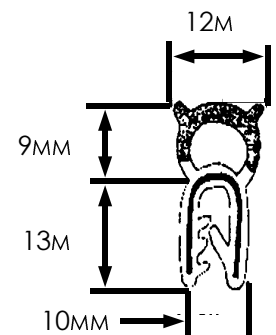

REPINCH-057

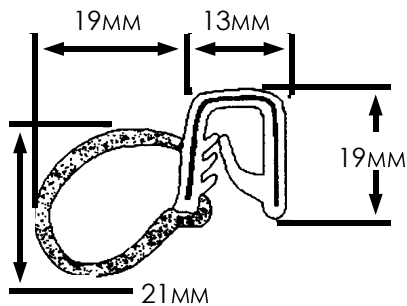

REPINCH-060

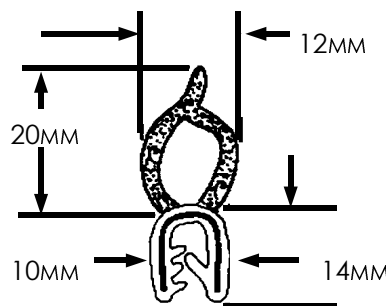

REPINCH-115

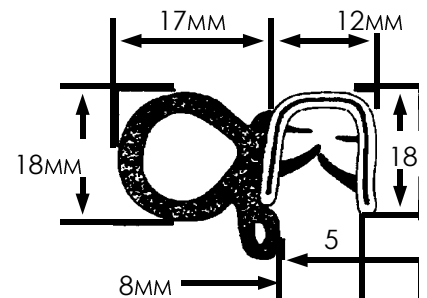

REPINCH-157

Pinchwelds - EPDM Rubber and Sponge

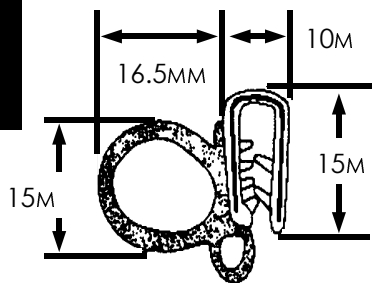

REPINCH-054- BLACK
REPINCH-054- CAMEL
REPINCH-054- BLUE/GREY
 EQUIV TO BS 283879

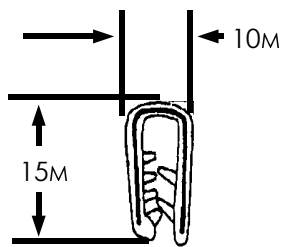

REPINCH-054BA- BLACK
REPINCH-054CA- CAMEL
REPINCH-054BG- BLUE/GREY

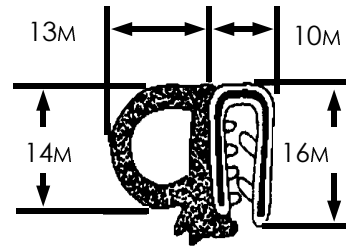

REPINCH-055N- BLACK

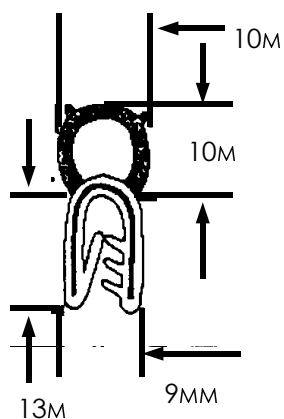

REPINCH-051SCH

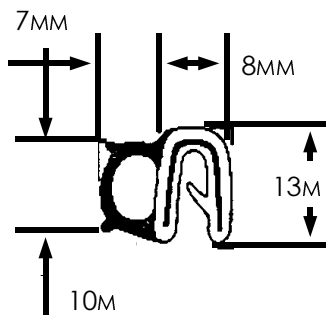

REPINCH-052SCH

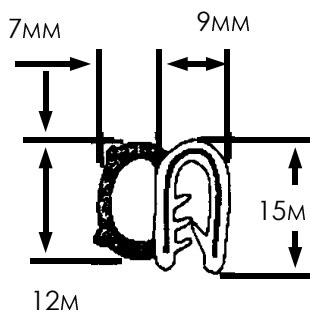

REPINCH-053SCH

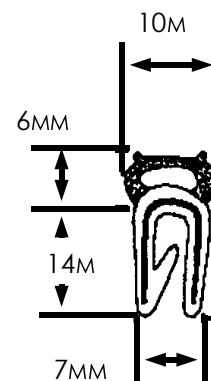

REPINCH-057SCH

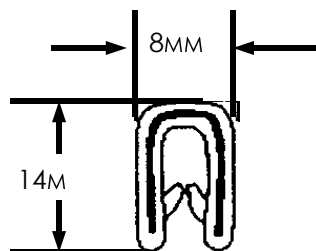

REPINCH-056

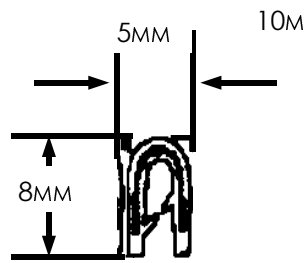

REPINCH-059

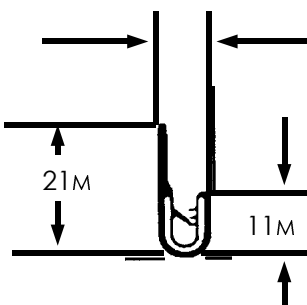

REPINCH-061

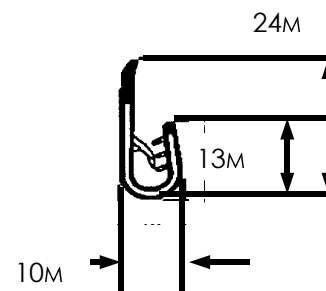

REPINCH-062

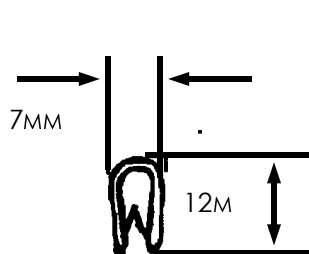

REPINCH-035

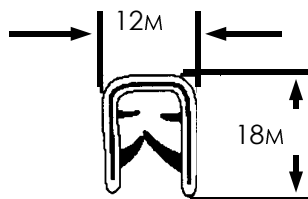

REPINCH-036/1 CHARCOAL
REPINCH-036/2 BLACK
 EQUIV TO BS 283879
REPINCH-036/3 BROWN
REPINCH-036/4 TAN

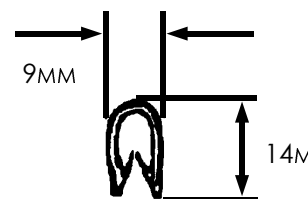

REPINCH-037

Pinchwelds - PVC / EPDM Rubber

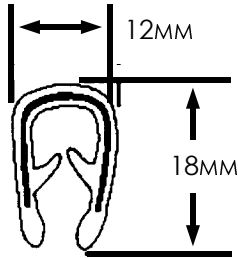

REPINCH-081 BLACK

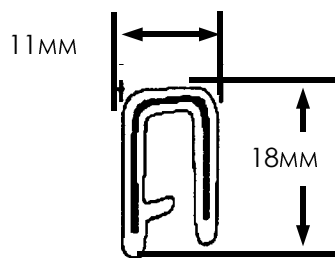

REPINCH-081 BLACK

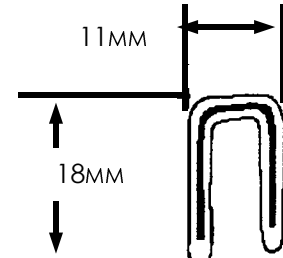

REPINCH-081 BLACK

Pinchwelds - PVC / Aluminium core

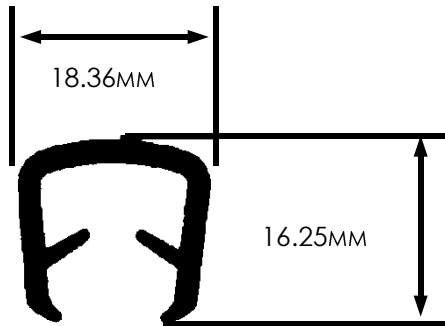

REPINCH-75001582 BLACK
REPINCH-75001620 WHITE
45 METRE COIL LENGTH
GRIPS EDGES FROM 6.35MM TO 12.7MM

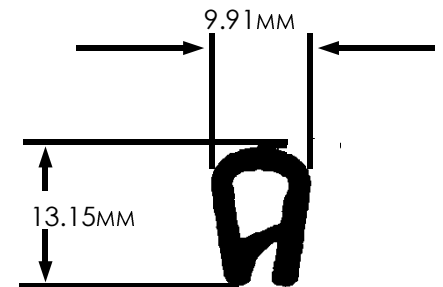

REPINCH-75001585 BLACK
REPINCH-75001623 WHITE
120 METRE COIL LENGTH
GRIPS EDGES FROM 1.52MM TO 4.32MM

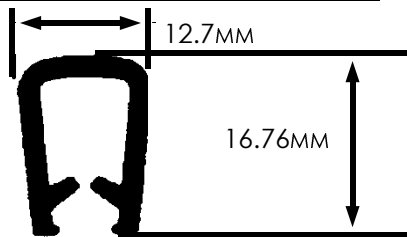

REPINCH-75001583 BLACK
REPINCH-75001621 WHITE
75 METRE COIL LENGTH
GRIPS EDGES FROM 3.43MM TO 6.35MM

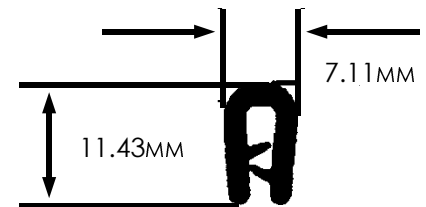

REPINCH-75001586 BLACK
REPINCH-75001624 WHITE
150 METRE COIL LENGTH
GRIPS EDGES FROM 0.25MM TO 1.27MM

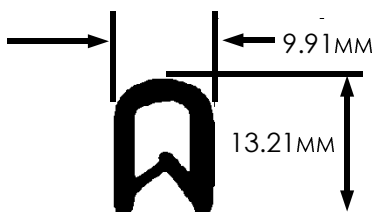

REPINCH-75001584 BLACK
REPINCH-75001622 WHITE
120 METRE COIL LENGTH

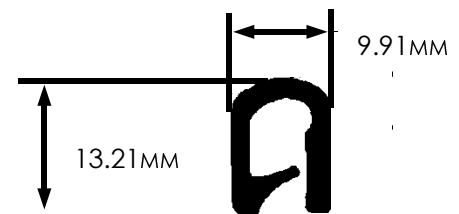

REPINCH-75000346 BLACK
REPINCH-75000348 WHITE
120 METRE COIL LENGTH
GRIPS EDGES FROM 2.29MM TO 11.03MM